

DZOFILM

MAKE YOUR MOVIE

CATTA Zoom Lens User's Manual

35-80mm, T2.9-T22
70-135mm, T2.9-T22

无邪系列变焦镜头
使用说明书

Contents

Introduction	1
Safety Notes	1
Lens Parts	2
Lens Control	3
Mount Changing	4
1. Mount Disassembling	4
2. Mount Installation	5
3. Install/ Disassemble the Rear Filter	6
Flange Back Adjustment	7
1. Preparation	7
2. Flange Back Adjustment	7
Specification	9
After-sales Service	10
The Name and Content of Hazardous Substances	11

Introduction

Thank you for your purchase of this product!

CATTA is DZOFILM's high-performance full frame cinema zoom lens. It allows you to reproduce the details and color in filming. Clear images, natural transition from in-focus to defocus and minimal breathing in focusing...all these can be found in CATTA zoom. A good companion for your documentary/ TVC/ MV/ commercials/ online movie/ variety show/ Live/ independent films, etc.

Safety Notes

- Please do not watch the sun or bright light source through the lens, otherwise it will cause visually disabled.
- Never use organic solvents such as paint thinner or benzene to clean the lens.
- Attach the front and rear caps when the lens is not in use.
- Store the lens and filter in cool, dry locations to prevent mold and rust. Do not store in direct sunlight or with naphtha or camphor moth balls.
- Please keep the lens dry and wipe the water droplets off if there are water droplets on the glass surface.
- Leaving the lens near heater or in other extremely hot locations could cause damage or warping.
- Use a blower to remove dust and lint from the glass surfaces of the lens or filter. To remove smudges and fingerprints, apply a small amount of lens cleaner to a soft, clean cotton cloth or lens-cleaning tissue and clean from the center outwards using a circular motion. Do not leave smears or touch the glass with your finger.

Lens Parts

- ① Front cap
- ② Lens Mark
- ③ Focusing Ring
- ④ Screw holes for accessories*10
(M3, 3mm deep)
- ⑤ Zoom Ring
- ⑥ Zoom Lever Socket
- ⑦ Aperture Ring
- ⑧ Lever socket of Mount
- ⑨ Lock Ring of Mount
- ⑩ Release Button of Mount
- ⑪ Plug-in Rear Filter
- ⑫ Rear Cap
- ⑬ Support base

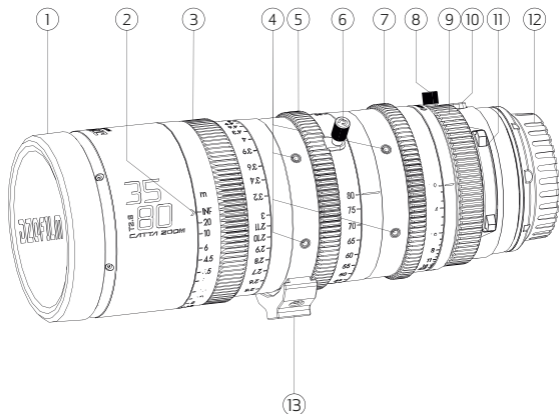

Lens Control

Focus Control

Rotate the focus ring to increase or decrease the focus distance.

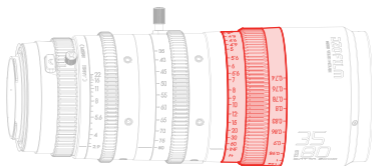

Zoom Control

Rotate the zoom ring to zoom out, increasing the area visible in the frame or zoom in on the subject so that it fills a larger area in the frame.

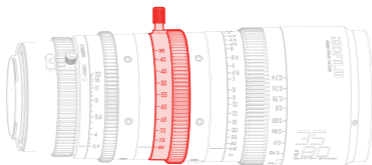

Aperture Control

Rotate the aperture ring to stop aperture down, raising the T-stop and narrowing the aperture, or lower the T-stop to widen the aperture.

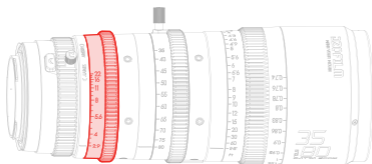

Mount Changing

Scan the code below to watch the tutorial video or go to [DZOFILM website - Support - Q&A - Lens Tutorials - CATTA](#) to watch the video. ([Click to jump to the website](#))



Note: In general situation, there is no need to adjust the shims after changing the mount. If you still need to adjust the flange back distance, please refer to the next section *Flange Back Adjustment*.

1.Mount Disassembling

Step One : Rotate the Lock Ring 90 degrees anticlockwise till the Ring cannot be rotated anymore.

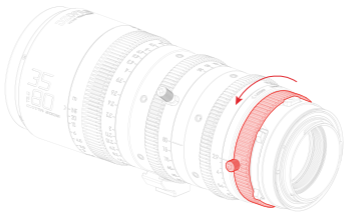

Step Two : Press Lock Button, rotate the mount (silver part) anticlockwise and in the meantime pull out the mount.

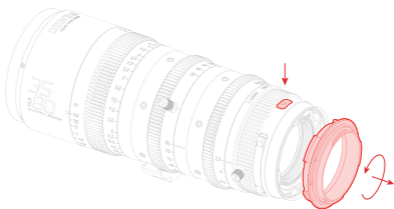

2. Mount Installation

Step One : Please make sure that the Lock Lever Socket is at the top left side (see in the picture).

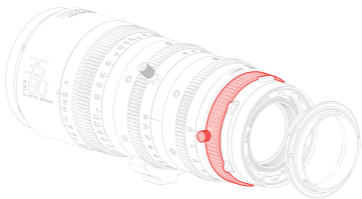

Step Two : Align the breach under the mount to the embossed screw on the mount plane, lay down the mount.

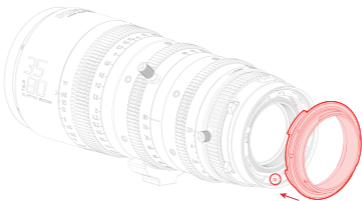

Step Three : Press the Lock Button and rotate clockwise till hear a sound of "clatter".

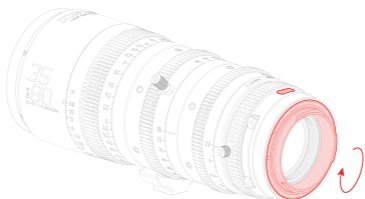

Step Four : Rotate the Lock Ring clockwise to the top. The mount is locked.

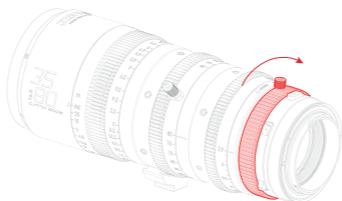

3. Install/ Disassemble the Rear Filter

Hold the handle of the rear filter and you can pull in or out the filter.

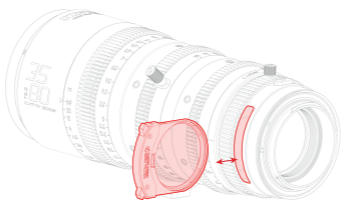

Flange Back Adjustment

DZOFILM will check and adjust flange back distance of all CATTAs before shipping. But the flange back distance might have slight difference among different cameras. To achieve the best performance and match different cameras, flange back adjustment is needed.

1. Preparation

Step One : Ready your subject. You can use a "Star Chart", or other high-resolution black-and-white objects;

Note : You can download and print the chart on DZOFILM website-Download-Star Chart for Adjusting Back Flange ([Click to jump to the website](#))

Step Two : Attach the lens to the camera;

Step Three : Select the maximum aperture (wide open);

Step Four : Set the object 1.5m away from the camera sensor plane, and adjust it to the center of the whole image.

2. Flange Back Adjustment

Step One : Rotate the zoom ring to the longest focal length, and rotate the focus ring until the image to its clearest, mark down the focusing distance S_1 ;

Step Two : Rotate the zoom ring to the widest focal length and rotate the focus ring until the image to its clearest, mark down the focusing distance S_2 ;

Step Three : Compare the difference between S_2 and S_1 . If $S_2 < S_1$, then need to add shims; otherwise decrease the shims,

Note : The shim adjustment is evaluated on the angle between S_2 and S_1 . If the angle is bigger, then need to change more shims and vice versa.

Step Four : Repeat step 1-2 until $S_2 = S_1$. Then it means the lens is under parfocal.

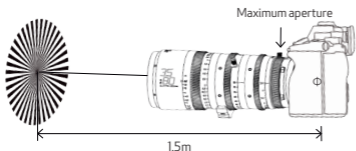

Set the object 1.5m away from the camera sensor plane, and adjust it to the center of the whole image.

Take CATA zoom 35-80mm as an example :

Rotate the focal length to 80mm, and focus till the image is at its sharpest, the focusing distance mark is 1.5m (S1). And then rotate the zoom ring to 35mm, re-focus to the image at its sharpest, current focusing distance mark is 1.4m (S2). $S2 < S1$. According to the sheet below, add 0.12mm shims on the lens mount and double check. At this time, both 35mm and 80mm focus at the closest under 1.5 focus mark. That means this lens is under parfocal.

35-80mm shim adjustment reference

80mm focusing mark S1 (m)	1.5								
35mm focusing mark S2 (m)	1.2	1.3	1.4	1.5	1.6	1.7	1.8	2	2.2
Shim adjustment (mm)	+0.3	+0.19	+0.12	0	-0.08	-0.13	-0.18	-0.23	-0.3

70-135mm shim adjustment reference

135mm focusing mark S1 (m)	1.5					
70mm focusing mark S2 (m)	1.4	1.45	1.5	1.55	1.6	1.65
Shim adjustment (mm)	+0.3	+0.13	0	-0.1	-0.22	-0.3

Note: Shim adjustment: "+" means adding shims, and "-" decreasing shims.

Specification

Specification		
Focal Length	35-80mm	70-135mm
Mount	E/RF/L/X/Z	
Aperture	T2.9-22	
Image Circle	Φ 43.5mm (FF)	
Close Focus (Metric/Imperial)	0.74m/2ft5in	0.76m/2ft6in
Zoom Ratio	2.3X	1.9X
Mag. Ratio (Close Focus)	35mm: 0.0657 80mm: 0.146	70mm: 0.112 135mm: 0.214
Flange Distance	E=18mm, L/RF=20mm, X=17.7mm, Z=17mm	
Iris Control	Manual, max 75°	Manual, max 80°
Focus Control	Manual, max 270°	
Zoom Control	Manual, max 100°	
Front Dia. (Metric/Imperial)	Φ 80mm/3.15"	
Filter Size	M77	
Length (Metric/Imperial)	From lens front plane to flange back: 212.4mm/8.36" (RF/L) ; 214.4mm/8.44" (E) ; 214.7mm/8.45"(X) ; 215.4mm/8.48"(Z)	
Iris Blade	16	
Weight	1532g	1597g

After-sales Service

Repairs : Return the product to the point of purchase for repairs. Please note that we reserve the right to refuse service in the event of damage so severe that there is little hope of function being restored, whether said damage is caused by physical shocks, exposure to or immersion in sand, mud, or water or the like.

Warranty service: Should the product malfunction in the course of normal use as set forth in the user's manual and accompanying documentation, it may be returned to the point of purchase for repairs within warranty period. The owner is responsible for all shipping costs. The warranty period varies with the country or region of purchase. Stored dated receipts or other proof of purchase in a safe place, as it will be required for repairs made under warranty.

Service Outside the Warranty Period: Request for service will normally be accepted within a period of roughly 5 years following the end of production, during which time spares will be kept on hand, although owners may be offered an equivalent product during this period in the event that spares are not available. Compatibility with consumables and accessories for the original product is not guaranteed. To prevent waste, repairs or replacement may be made using refurbished parts or products, and DZOFILM may collect returned parts or products for later use. When returning a product for repair, please let us know if you need the original parts.

Privacy: DZOFILM obeys all applicable laws and regulations concerning the handling of names, addresses, phone numbers, and other personal information provided by users.

The Name and Content of Hazardous Substances

Part Name	Hazardous Substances					
	Pb	Hg	Cd	Cr(VI)	PBB	PBDE
Lens Shell	○	○	○	○	○	○
Inner Mechanics	×	○	○	○	○	○
Optics	○	○	○	○	○	○
Other Parts	○	○	○	○	○	○

This table is formulated in accordance of SJ/T11364.

○: Indicates that the concentration of the hazardous substance in all homogeneous materials in the parts is below the relevant threshold of the GB/T26572 standard.

×: Indicates that the concentration of the hazardous substance of at least one of all homogeneous materials in the parts may be above the relevant threshold of the GB/T26572 standard.

The "×" in the above table indicates that there are one or more exemptions are applied in the parts stated in RoHS (2011/65/EU).

目录

简介	1
安全注意事项	1
镜头部件	2
镜头控制	3
卡口更换	4
1.卡口拆卸	4
2.卡口安装	5
3.滤镜片的拆卸/安装	6
后焦调节	7
1.准备工作	7
2.调节后焦	7
技术规格	9
售后服务	10
产品中有害物质的名称及含量	11

简介

感谢您购买本系列产品!

无邪 (CATTa) 系列是DZOFILM旗下的全画幅高性能变焦镜头,可以让您在视频创作时还原拍摄细节,色彩通透、过渡均匀自然。适合在纪录片、MV、中型商业片、网络电影、直播等场景使用,较小的呼吸效应使画面焦点转换更自然。

安全注意事项

- 请勿透过镜头或相机观看太阳或明亮的光源,否则会使视力受损;
- 切勿使用涂料稀释剂或苯等有机溶剂清洁镜头;
- 不使用镜头时,请盖上镜头前后盖;
- 为防止发霉,请将镜头和滤镜存放在阴凉、干燥的地方,切不可存放在直射阳光下,也不要与石脑油或樟脑丸放在一起;
- 请保持镜头干燥,如受潮或有水滴请擦拭干净后存放;
- 勿将镜头放置在加热器旁或其他极其炎热的地方,可能导致损坏或变形;
- 请使用吹气球去除镜头或滤镜玻璃表面的灰尘,若要去除污点和指纹,可用一块滴有少许镜头清洁剂的干净软绵布或镜头清洁纸,以圆周运动方式从里向外进行清洁,注意不要留下污渍,也不要用手指触摸玻璃;

镜头部件

- ① 镜头前盖
- ② 镜头标记
- ③ 对焦环
- ④ 附件扩展孔位*10 (M3,深3mm)
- ⑤ 变焦环
- ⑥ 变焦拨杆
- ⑦ 光阑环
- ⑧ 卡口解锁环拨杆
- ⑨ 卡口解锁环
- ⑩ 卡口释放按钮
- ⑪ 插入式后置滤镜
- ⑫ 卡口后盖
- ⑬ 支撑座

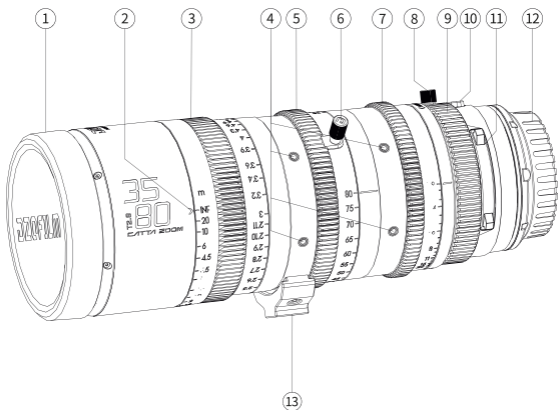

镜头控制

对焦控制

旋转对焦环,可增加或减少对焦距离,从而调整画面中的焦点位置。

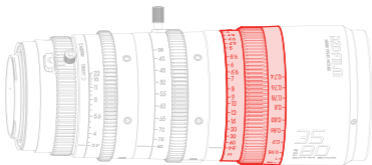

变焦控制

旋转变焦环,可放大或缩小画面中的可视区域以及被摄主体的大小。

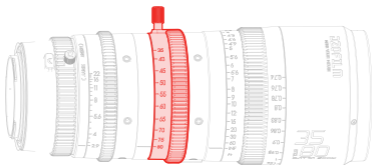

光圈控制

旋转光圈环,可放大或缩小光孔直径,调整画面明暗度以及被摄主体的背景虚化效果。

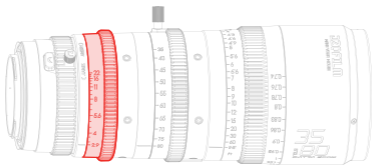

卡口更换

扫描下方二维码观看视频教程，或进入 DZOFILM官网 - 服务与支持 - Q&A - 镜头使用教程，在CATT(A无邪)系列中观看视频教程。[\(点击此处跳转\)](#)



提示：一般情况下，更换卡口后无需调整垫片，如更换后需调整后焦，请参考下方“后焦调节”章节进行操作。

1. 卡口拆卸

步骤一：将锁紧环逆时针旋转90度，直到转动至不可旋转为止。

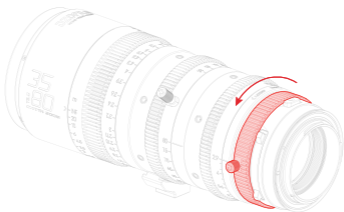

步骤二：按下卡口解锁按钮，逆时针旋转卡口并向上提出，完成卡口拆卸。

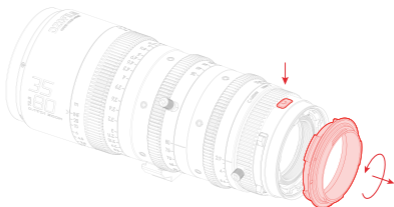

2.卡口安装

步骤一：请确认锁紧环拨杆位置处于最左侧，对应图中的位置。

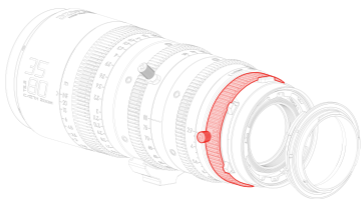

步骤二：将卡口底部的缺口部位对准卡口平面内凸起的小螺丝标记处,放下卡口。

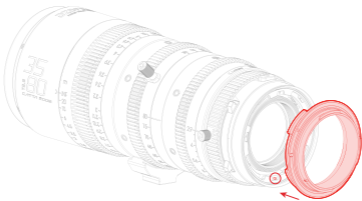

步骤三：按下卡口解锁按钮并顺时针旋转,听到“咔哒”声即可停止旋转。

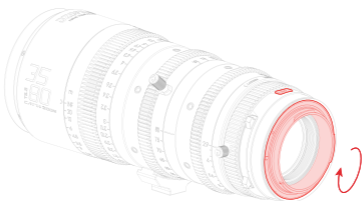

步骤四：顺时针旋转锁紧环至顶部位置，即完成卡口安装。

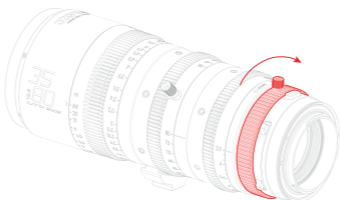

3. 滤镜片的拆卸/安装

捏住后置滤镜片把手，可直接抽出或推入滤镜片，完成拆卸或安装。

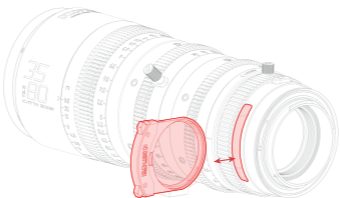

后焦调节

无邪系列镜头在出厂前会按照标准调整后焦，但不同相机的法兰距在出厂时可能会有一点不同，为了方便与不同的相机匹配，达到最佳成像效果，需要进行后焦调节操作。

1.准备工作

步骤一：准备好拍摄对象。可使用“星状测试图”，或使用其他黑白相间的、对比度较高的拍摄对象；

提示：可前往“DZOFILM官网-资料下载-后焦调整星图”处下载[\(点击此处跳转\)](#)

步骤二：镜头安装到相机或摄影机上；

步骤三：镜头调整为最大光圈；

步骤四：将拍摄对象放置在距离相机成像面约1.5米处，并调整其位置在画面中心。

2.调节后焦

步骤一：旋转变焦环至最长焦端，然后旋转对焦环至画面最清晰状态，记下此时的对焦刻度值S1；

步骤二：旋转变焦环至最广角端，然后旋转对焦环至画面最清晰状态，记下此时的对焦刻度值S2；

步骤三：对比S2与S1的大小，若S2小于S1，则需要增加后焦垫片；若S2大于S1，则需要减少后焦垫片；

提示：垫片的调整量与S1，S2的差值对应的对焦环旋转角度有关，旋转角度越大，需要调整的垫片越多，反之亦然；

步骤四：重复1-2步骤，直到S2等于S1时，说明镜头已处于齐焦状态，完成后焦调节。

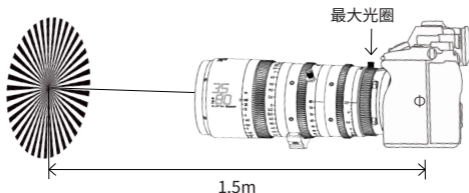

将拍摄对象在距离相机成像画面“Φ”标记处约1.5m放置，
将拍摄对象位于画面中心。

例：

以CATTa zoom 35-80mm为例，假设镜头变焦至80端，对焦至画面最清晰时，对焦刻度值为1.5m，再将镜头变焦至35端，重新对焦至画面最清晰时，对焦刻度值为1.4m，比1.5m小，参考下方“后焦垫片调整参考表”，将后焦垫片增加0.12mm后，重新确认，80端和35端，画面最清晰时对焦刻度值都在1.5m，说明镜头已处于齐焦状态，后焦调节完成。

35-80mm后焦垫片调整参考表									
80端对焦 刻度值S1(m)	1.5								
35端对焦 刻度值S2(m)	1.2	1.3	1.4	1.5	1.6	1.7	1.8	2	2.2
后焦垫片 调整参考值(mm)	+0.3	+0.19	+0.12	0	-0.08	-0.13	-0.18	-0.23	-0.3

70-135mm后焦垫片调整参考表						
135端对焦 刻度值S1(m)	1.5					
70端对焦 刻度值S2(m)	1.4	1.45	1.5	1.55	1.6	1.65
后焦垫片 调整参考值(mm)	+0.3	+0.13	0	-0.1	-0.22	-0.3

提示：后焦垫片调整值，“+”代表要增加垫片，“-”代表要减少垫片。

技术规格

技术规格		
焦距	35-80mm	70-135mm
卡口	E/RF/L/X/Z	
光圈	T2.9-22	
最大像面	43.5mm(全画幅)	
最近对焦距离 (米制/英制)	0.74m/2ft5in	0.76m/2ft6in
变焦倍率	2.3X	1.9X
放大倍率 (最近对焦位置)	35端,最近距离的 放大倍率:0.0657 80端,最近距离的 放大倍率:0.146	70端,最近距离的 放大倍率:0.112 135端,最近距离的 放大倍率:0.214
法兰距	E=18mm, L/RF=20mm, X=17.7mm, Z=17mm	
光圈控制	手动(旋转最多75°)	手动(旋转最多80°)
对焦控制	手动(旋转最多270°)	
变焦控制	手动(旋转最多100°)	
前端直径 (米制/英制)	80mm/3.15"	
滤镜直径	M77	
长度 (米制/英制)	从镜头前端面至法兰面: 212.4mm/8.36"(RF/L);214.4mm/8.44"(E); 214.7mm/8.45"(X);215.4mm/8.48"(Z)	
叶片数量	16	
重量	1532g	1597g

售后服务

维修: 请将本产品送回至销售点进行维修。请注意,当损坏过于严重以致功能无法恢复时,不论该损坏是因碰撞、火烧还是浸没于沙土、水中等原因所致,我们均保留拒绝服务的权利。

保修服务: 若产品是在按照用户手册正常使用期间发生故障,您可在保修期内将其送回至销售点进行维修,用户需承担所有运费。保修期根据出售国或销售地的不同而异;由于在保修期内进行维修时将需要使用收据或购买凭证,请将注明日期的收据或其他购买凭证存放在稳妥的地方。

保修期外的服务: 本产品的配件可在生产后大约持有5年,用户一般可在此期间请求维修、更换服务,但在配件不可用的情况下,可能为用户提供同等产品。此时与原产品耗材和配件的兼容性不予保证。为杜绝浪费,维修或更换可能会采用翻新部件或产品,并且DZOFILM可能会收集返修部件或产品以供日后使用。产品返修时,请告知我们是否需要原装部件。

隐私: DZOFILM遵循所有关于处理用户所提供的姓名、地址、电话号码以及其他个人信息的现行法律和法规。

产品中有害物质的名称及含量

部件名称	有害物质					
	铅 (Pb)	汞 (Hg)	镉 (Cd)	六价铬 (Cr(VI))	多溴联苯 (PBB)	多溴二苯醚 (PBDE)
镜头外壳部件	○	○	○	○	○	○
机械部件	×	○	○	○	○	○
光学部件	○	○	○	○	○	○
其它部件	○	○	○	○	○	○

本表格依据SJ/T11364的规定编制。

○:表示该有害物质在该部件所有均质材料中的含量均在GB/T26572规定的限量要求以下。

×:表示该有害物质至少在该部件的某一均质材料中的含量超出GB/T26572规定的限量要求。

对于表示"×"的情况,属于欧盟RoHS指令(2011/65/EU)的豁免项目。

Shenzhen Dongzheng Optical Technology Co., Ltd.

1F., Building One, Xinwuxia Industrial Park, No.32, Cuibao Rd., Baolong St., Longgang Dist., Shenzhen 518000, China

 www.dzofilm.com

深圳市东正光学技术有限公司

广东深圳市龙岗区宝龙街道翠宝路32号
新屋吓工业园1栋1楼

 www.dzofilm.com



 www.dzofilm.com



 WECHAT: DZOFILM